



SOLUTIONS for

Lump Breaking & Grinding

GRANULATION

LUMP BREAKING

CRUSHING

MICRONIZATION

DEAGGLOMERATION

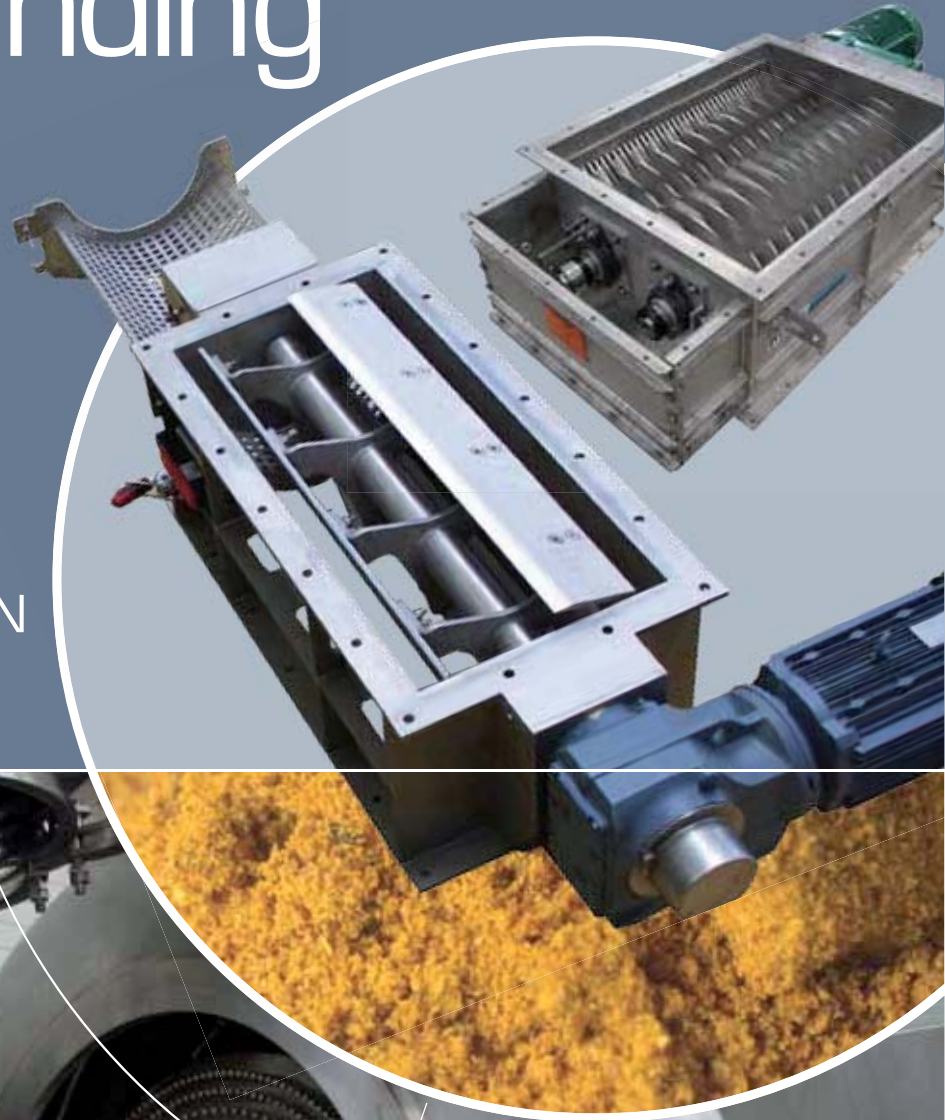

Palamatic

PROCESS >>> machines • engineering

Powder Handling Solutions



Means that the equipment is available for testing at PALAMATIC PROCESS



Means that the equipment can be installed in ATEX zone



Means that design and options can be customised

PALAMATIC PROCESS reserves the right to make changes in the design of the facilities listed in this commercial documentation

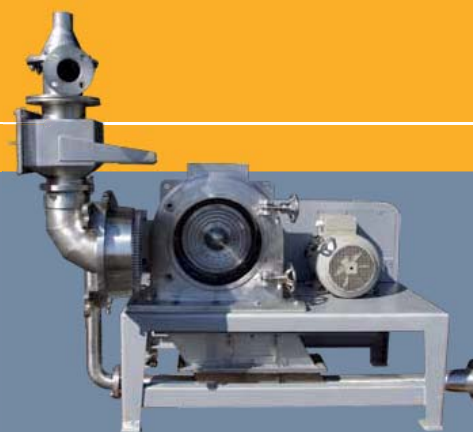

- ▶ **LUMP BREAKING & GRINDING** **02**
- Presentation** 02
- ▶ **LUMP BREAKERS** **04**
- Lump breakers STANDARD RANGE** 04
- Plans** 06
- Technical characteristics** 08
- Test plant - Laboratory for powders** 09
- Examples of installations** 10
- ▶ **GRANULATORS** **12**
- Granulators STANDARD RANGE** 12
- Plans** 14
- Technical characteristics** 16
- CUSTOM MADE Granulators** 18
- Examples of installations** 20
- ▶ **GRINDING MILLS** **22**
- Grinding mills STANDARD RANGE** 22
- Technical characteristics** 24
- Examples of conceptions** 26
- Examples of installations** 28
- ▶ **ATEX** **32**
- ATEX Guide** 32

Lump breaking - Granulation - Grinding

PALAMATIC PROCESS HAS DEVELOPED A COMPLETE RANGE OF MACHINES TO ENSURE THE REQUIRED PARTICLE SIZE

Lump breakers
EC



- Crushing, grinding of materials that tend to form lumps

Page 04

Granulators
GR

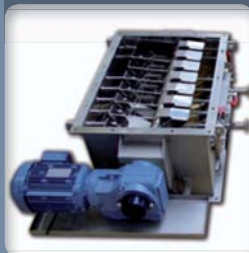

- Bulk products deagglomeration and granulation

Page 12

Grinding mills
UM



- Grinding of a wide variety of bulk and powdery materials

Page 22

PALAMATIC PROCESS offers machines ensuring granulometric reduction. The choice of equipment is made according to the processed material, the flow rate and the desired particle size. Each technology benefits from the PALAMATIC PROCESS experience gained due to its test center and the numerous installations in operation.

Comparative table of the different technologies

	Output particle size	Maximum input particle size	Maximum flow rate
Lump breaker EC	50 mm — 10 mm	300 mm	80 t./hr.
Lump breaker EC fitted with fixed grid	30 mm — 5 mm	250 mm	40 t./hr.
Granulator GR	80 mm — 1 mm	200 mm	15 t./hr.
Grinding mill UM	1 mm — 10 µm	10 mm	4 t./hr.

Our design office ensures the integration of machines into production lines or on different equipment.

Given the processed powders, PALAMATIC PROCESS has developed several principles of breaking up lumps. Waxy, fat or heat sensitive materials, choice of knives speeds or shape of the calibration mesh (round, square, clover shaped) are important factors to ensure the proper functioning of your system. The hardness of the material and particle sizes will impact the type and shape of the knives. Our experience combined with the knowledge of your material, as well as our test center, are essential to select the right equipment.

LUMP BREAKER

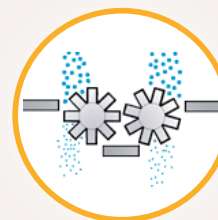

The lump breaker ensures the crumbling of material that tends to cake and is especially suitable for compact materials with large clods. The fibrous, fatty materials or products heavily loaded with liquid can be treated with our lump breaker. The PALAMATIC PROCESS range of lump EC breakers consists of 3 standard models: EC35, EC50 and EC70. Each model has two shafts fitted with knives and a calibration grid.

GRANULATOR

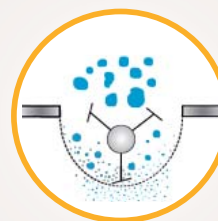

The PALAMATIC PROCESS granulator ensures the deagglomeration of materials. The removable calibration trough ensures strict control of the output particle size. Our granulator can be used in the food, veterinary or cosmetics industries. Our product range is composed of 4 models: GR20, GR35, GR50 and GR70. Calibration troughs are interchangeable to adapt to different processes.

GRINDING MILL

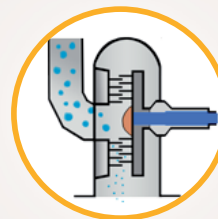

PALAMATIC PROCESS grinding mill UM is designed for the micronization of powders. The principle of operation is the particle breakup by the shock generated between the static pins and rotating ones. Extremely high rotational speeds enable ensuring output sizes smaller than 50 microns. The four models in the standard range GR20, GR35, GR50 and GR70 offer high flow rates.

Lump Breakers



Lump breaker range
3 standard models: EC35 EC50 EC70

CRUSHING, LUMP BREAKING, GRANULATING

OPERATING SEQUENCE

The opposite rotation of the two knife shafts allows to obtain high flow rates.

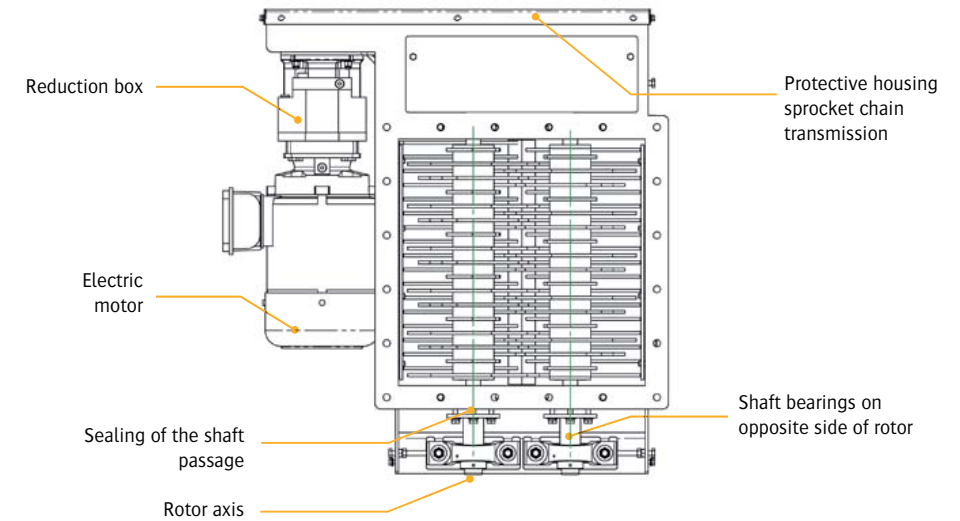
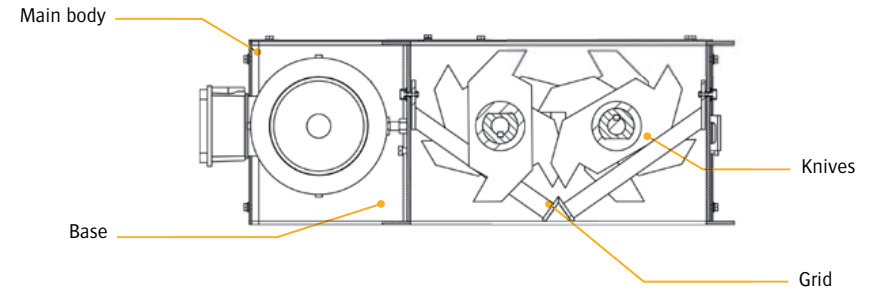
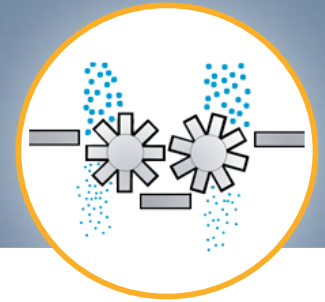

Models	Rotor speed in rev./min.*	Theoretical throughput in t./hr**	Flange dimension for connection in mm	Engine power in kW	Fastening flange in mm
EC35	200	25 à 35	375 x 375	3	445 x 445
EC50	180	40 à 50	525 x 525	5,5	600 x 600
EC70	180	50 à 80	700 x 700	8	800 x 800

* The speed is adjustable according to the characteristics of products and ATEX properties.
** On density 1 product

The lump breaker is the perfect solution for crushing materials that tend to form lumps. The device allows to break clods that are formed during the production process. The rapid rotation of knives through a fixed grid provokes lump crumbling. The presence of two rotors provides high flow rates.



3 standard models:
EC35 - EC50 - EC70

▶ LUMP BREAKER EC35

Model	EC35
Rotor speed in rev./min.	200
Theoretical throughput in t./hr.	25 to 35
Flange dimension for connection in mm	375 x 375
Engine power in kW	3
Fastening flange in mm	445 x 445

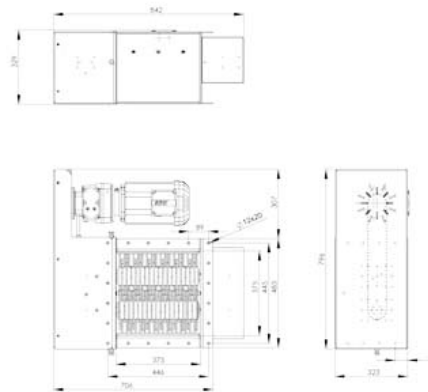

▶ LUMP BREAKER EC70

Model	EC70
Rotor speed in rev./min.	180
Theoretical throughput in t./hr.	50 to 80
Flange dimension for connection in mm	700 x 700
Engine power in kW	5,5
Fastening flange in mm	800 x 800

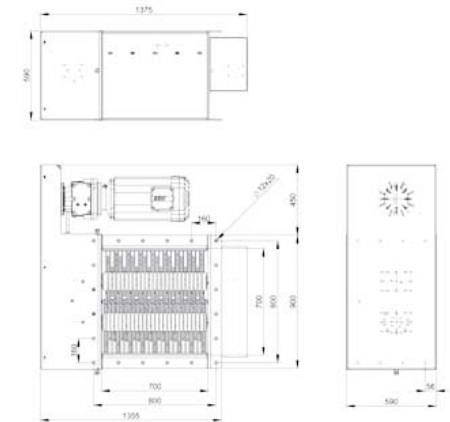

▶ LUMP BREAKER EC50

Model	EC50
Rotor speed in rev./min.	180
Theoretical throughput in t./hr.	40 to 50
Flange dimension for connection in mm	525 x 525
Engine power in kW	5,5
Fastening flange in mm	600 x 600

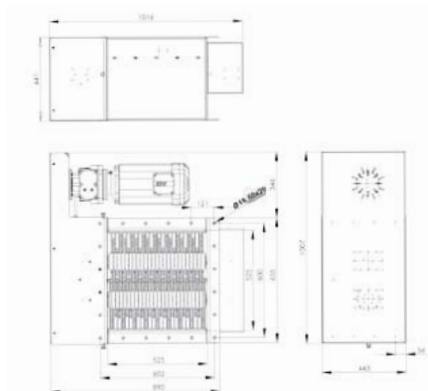

▶ POSSIBLE FEATURES - CUSTOMIZED SOLUTIONS

- ATEX standards 20/21/22
- Shape of the blades depending on the material
- Modular dimensions of the material passage
- Constant or variable speed motorization
- Rotation monitor
- Chain or gear drive
- Stainless steel manufacturing

Our design office provides you with equipment that perfectly meets your dimensional constraints and use.

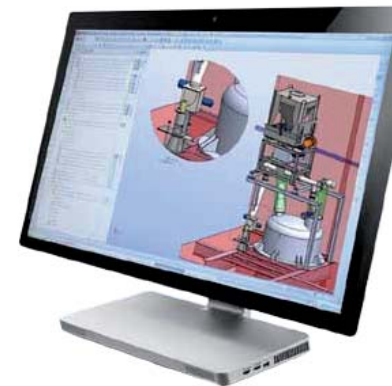

Lump Breakers

Mild steel, 304L stainless steel and 316L stainless steel manufacturing
Flow rate from 1 to 50 m³/hr.

TECHNICAL CHARACTERISTICS

The objective of the lump breaker is to ensure feeding of the process with deagglomerated materials. Lumps must go through a deflector. The lump breaker includes two pin shafts. This model is recommended in case of friable lumps, without moisture absorption.

The lump breaker consists of a square section body with an upper and lower flange, 2 horizontal parallel shafts, a mesh for big sizes, 4 shaft bearings with adjustable shaft seal and an appropriate drive unit with transmission.

Advantages



Fixed grids

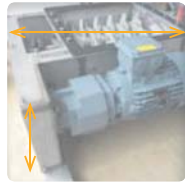

Small dimensions



Chain drive



Shaft passage sealing

CONCEPTION

The lump breaker can operate in continuous feed or positioned under a hopper.

- . ATEX standards 20/21/22
- . 3 available standard sizes (25 to 80 m³/hr.) or custom manufacturing
- . Built with 2 rotors with blades for lump breaking and a mesh in order to reduce the passage space
- . Constant or variable speed motorization, chain or gear drive
- . Manufacturing: carbon steel, stainless steel 304L and 316L

Exploded view of the lump breaker

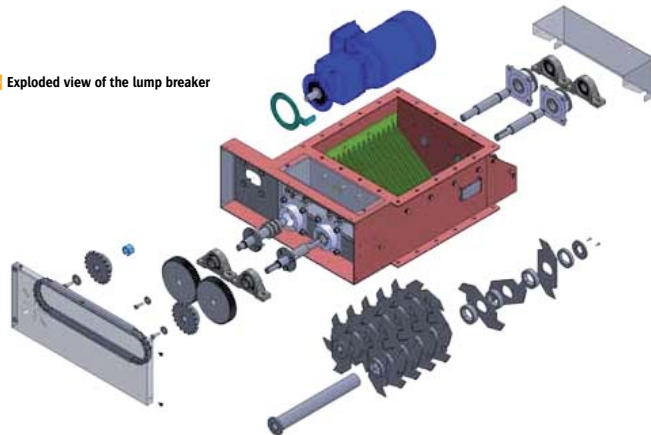

Test Plant Laboratory for powders



MATERIALS HANDLED

Boric acid, Critic acid, Clay, Glucose, Ammonium nitrate, Nitrate, Barite, Sodium nitrate, Smoke black, Salt, Sugar, Magnesium Sulfate, Talc, Urea, Sewage sludge, Milk powder...

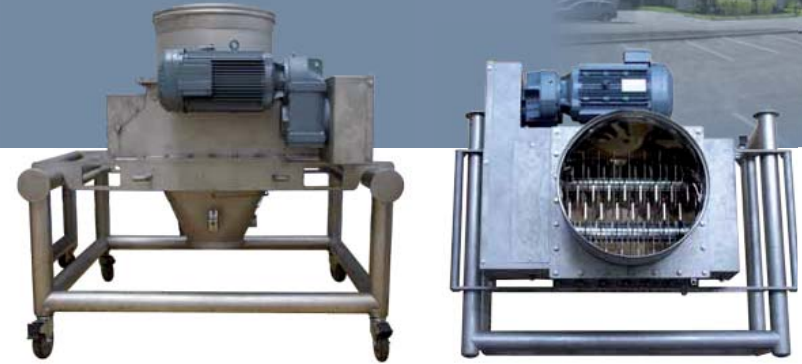

INDUSTRIAL SCALE TESTS & FLEXIBILITY

The lump breaker, available for testing, can be used as a whole unit or integrated into a big bag emptying station, a container or a bag dump station.

EXAMPLES OF TESTS

Carrots



Onions



Brown sugar



Washing powder



See our lump breaker testings in video on our YouTube channel:
www.youtube.com/user/Palamicprocess



Examples of Lump Breaker Installations

LOADING RESINS IN ATEX 20 PRESSURIZED REACTORS

Customer: Petrochemical plant for the manufacture of varnishes and gelcoat

Products: Resins

Installation details:

- 1- Stop loading through the manholes to ensure complete safety for the operators
- 2- Set up a booth on the ground for the discharge of raw materials (flakes & powder) ensuring efficiency, ergonomics and safety

The objective of the lump breaker is to ensure the feeding of the pneumatic conveying system with fluid material free of lumps. The material is conveyed pneumatically into the reactors and its dissolution is improved.



EXTRACTION UNDER SILO

Customer: Chemist

Products: Amino acid

Installation details: The storage of raw materials in large capacity silo can cause the caking of products at the bottom of these silos. In this application, PALAMATIC PROCESS has implemented a highly sized lump breaker EC70 directly under the silo. The high extraction rate ensures the loading of bulk tanks in the time required by the customer. A loading spout for trucks completes the installation device.



DISSOLVING TANK FEEDING

Customer: Nuclear energy

Product: Boric acid

Installation details: PALAMATIC PROCESS lump breakers EC50 are implanted at 2 stages of the feeding process:

- 1- The unpacking of bags of acid boric is done manually by the operators upstream of the process. Boric acid is received in the intermediate storage containers.

The lump breaker integrated in the sack dumping station provides a product in powder form.

- 2- The second step of crumbling is located above the dissolving tank. Containers prepared in phase 1 feed this lump breaker.

The feeding of the dissolution vessel being a crucial point to the security of the site, the setting up of the lump breaker was essential for dealing with the hydrophobic characteristics of the product.

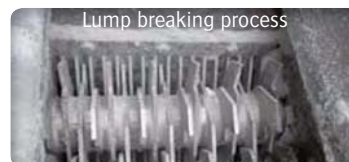

REMELTING LINE OF RECYCLED SUGAR

Customer: Sugar industry

Product: Crystal sugar

Installation details: To reintroduce non-satisfying products, PALAMATIC PROCESS has implemented a complete unit for big bag dumping to feed the sugar tanks.

The long-term storage in big bags (storage + stacking) causes caking amidst the product where lumps are forming.

The big bag dump station, equipped with massage devices, ensures the extraction of the product. This equipment combined with the lump breaker EC50 ensures a «free of lumps» feeding of the process. A magnetic detector completes the installation to meet food requirements.



Granulators



Granulators range

DEAGGLOMERATE MATERIALS HAVING TENDENCY TO CAKE

PRESENTATION

The implementation of a granulator greatly facilitates the flow of product and its further use. It deagglomerates the product by the action of rotary blades forcing the product to pass through a sizing screen.

PALAMATIC PROCESS granulators can be implemented on various dumping units or storage hoppers: big bag emptying stations, bag opening units, silos...

The implementation of the granulator can be performed on new or existing equipment. Our design office ensures its integration to your existing line.

OPERATING PRINCIPLE

The granulator is made of three or four chamfered paddles or scraper blades mounted on the radius of a 90° shaft. Lumps come against a sieve which mesh size should be defined (standard mesh 5x5, 10x10, 30x30, 50x50 mm).

Depending on the material, removable bars provide a first «breaking» of the clods. The granulator can be installed transversely (over the entire width of the machine) to ensure a high flow rate.

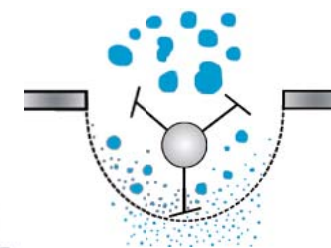

Option



Pre-crushing bars for extremely caked products with high hardness level

Granulator GR35 fitted with 3 interchangeable grids according to the materials to be treated



Models	GR20	GR35	GR50	GR70
Dimensions of the passing flange in mm*	200 x 200	200 x 450	300 x 650	400 x 900
Theoretical flow in m ³ /hr.	2	3	10	15

Thanks to its robust design and the numerous applications already effected, the granulator offers excellent reliability of desagglomeration.

Designed with a high mechanical resistance, it does not only offer safety and efficiency of use but also easy maintenance and cleaning. The risk of cross contamination is nil.

PALAMATIC PROCESS granulators are available in painted steel, stainless steel 304L and 316L and adapt well the requirements of each process.

4 standard models:
GR20 - GR35 - GR50 - GR70

▶ GRANULATOR GR20

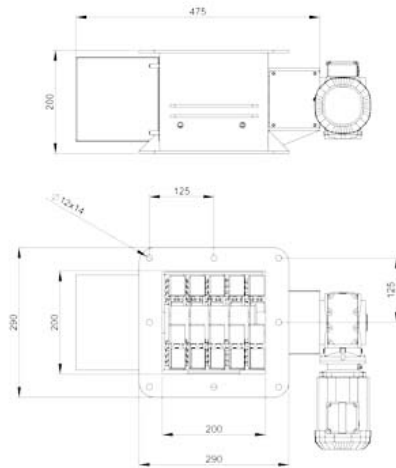

GR20

Model	GR20
Material passage in mm	200 x 200
Theoretical flow in m ³ /hr.	2
Engine power in kW	2,2
Rotation speed in rev./min.	30

▶ GRANULATOR GR50

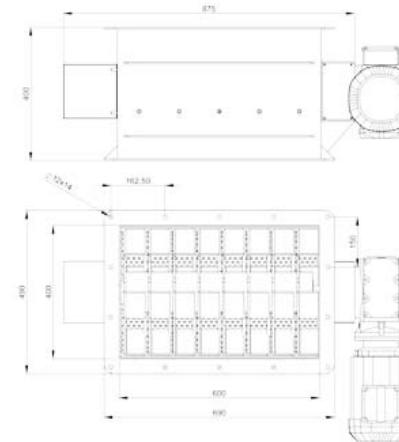

GR50

Model	GR50
Material passage in mm	300 x 650
Theoretical flow in m ³ /hr.	10
Engine power in kW	5,5
Rotation speed in rev./min.	20

▶ GRANULATOR GR35

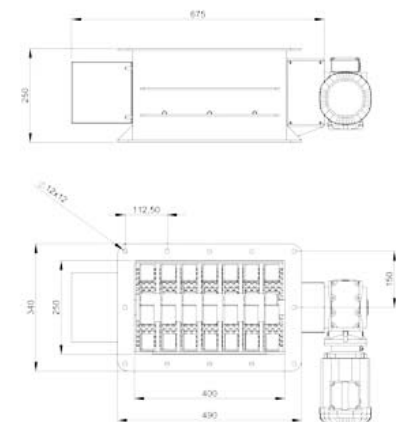

GR35

Model	GR35
Material passage in mm	200 x 450
Theoretical flow in m ³ /hr.	3
Engine power in kW	3,3
Rotation speed in rev./min.	30

▶ GRANULATOR GR70

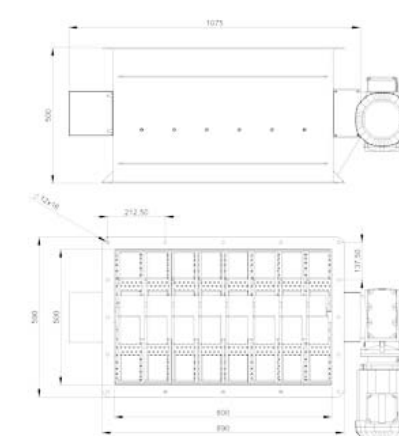

GR70

Model	GR70
Material passage in mm	400 x 900
Theoretical flow in m ³ /hr.	15
Engine power in kW	7,5
Rotation speed in rev./min.	15

Advantages



➤ **Removable and interchangeable trough:** depending on the material to be treated, the operator selects a proper calibration grid.



➤ **Removable grid:** the grid is easily removable (disassembly time <1 min.). A security strike provides operator's protection.



➤ **Ease of maintenance and cleaning:** the hygienic design as well as wide access flanges make the equipment easy to clean with clean in place options.



➤ **Optional mirror polished finish:** depending on the materials to be treated and cleaning constraints, specific finishes are available: mirror polished, PTFE or Teflon.

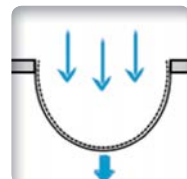

➤ **High flow rates:** the range of PALAMATIC PROCESS granulators GR ensures a wide choice of flow rates up to 20 t. / hr. (standard version)



➤ **Security strike:** all removable parts of the granulator (inspection doors, grid) are secured by the setting up of inviolable 3-state strikes (open / closed / locked).



➤ **Detached bearing:** the design focuses on use in difficult areas. Particular attention is given to the shaft passage: detached bearing on plate and plated sealing strips. Option: rotation and temperature sensors.

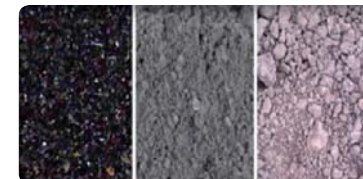

➤ **Multi-products:** PALAMATIC PROCESS' experience ensures operation over a wide range of materials. For very specific materials, tests can be carried out in our testing station.

TECHNICAL CHARACTERISTICS

- Calibration grid easily removed and cleaned (drawer system)
- Passing diameter is adjustable to each material
- Full aperture of the inlet and outlet flange
- Separated bearings with grounding straps and connection sealing
- Chamfered knives or scrapers blades
- Rotation speed adjustable with frequency drive

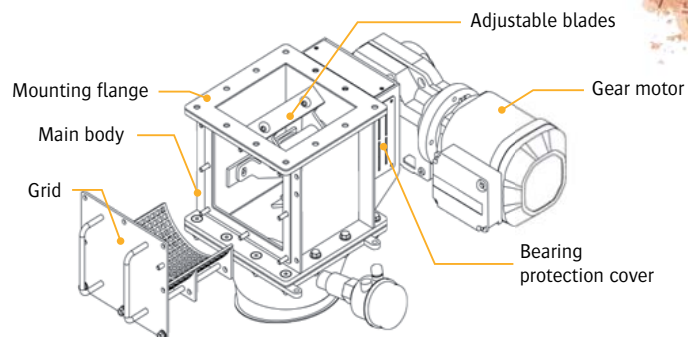

TEST PLANT



Our equipment is available for testing. We can perform tests on granulator, lump breaker and grinding mill. Such flexibility allows us to define with you the most suitable PALAMATIC PROCESS equipment for your material.



EXAMPLES OF TESTS

Zucchini



Boric acid



➤ Discover our lump breaker tests on our YouTube channel: www.youtube.com/user/Palamicprocess



Granulators

Custom Made



Custom Made

Painted steel, 304L stainless steel,
316L stainless steel manufacturing

CUSTOM MADE DESIGN

FEATURES

- Very high flow rates
- Suitable for fragile materials
- Security of use
- Removability of the grid
- ATEX standards

The PALAMATIC PROCESS design office is able to offer very specific granulating solutions for your pneumatic transfer applications according to your constraints and your flow rates. We define with you the customized solution after visiting your site and according to your detailed specifications.

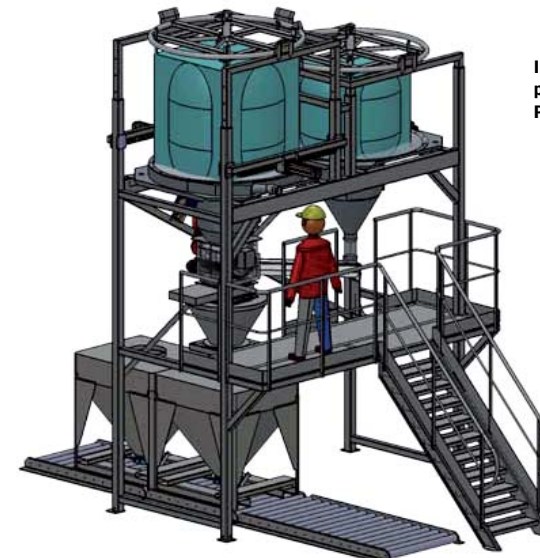

Integration of a customized granulator on a complete process line designed and manufactured by PALAMATIC PROCESS.

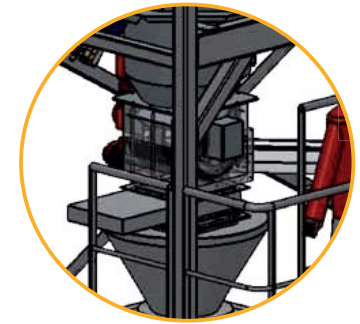

Our design office suits your specific machine constraints. Tests conduction with our expertise and knowledge of your process provide a strong synergy for the success of the installation.



Technical questionnaires available on www.palamaticprocess.com

Examples of Granulator Installations

▶ SUGAR DISSOLUTION LINE FOR MANUFACTURE OF YOGURT

Customer: Yogurt manufacturer

Products: White sugar, brown sugar, organic sugar

Installation details: The big bag dump station is set on load cells. The product is sucked for feeding a dispersion vessel. The product passes through a granulator GR20 to prevent clogging in the conveying piping and also to increase the rate of dissolution. Thanks to its design, the entire process line meets the ATEX and hygienic constraints imposed by the field of food industry.



▶ CONTAINER FILLING PROCESS LINE

Customer: Manufacturer of components for metallic alloys

Product: Calcium

Installation details: The line is designed for the conditioning of raw materials to containers. Raw materials are unpacked from big bags. Due to the specification of the process, the powder must be completely free of clods. The granulator GR50 ensures the crumbling of the product while respecting all the ATEX standards. Indeed, the product is very sensitive to friction phenomenon; the design office PALAMATIC PROCESS suggested equipment meeting the requirements by including rotation speeds, temperature sensors, operating games and materials compatible with this friction constraints.



▶ MANUFACTURING LINE FOR DETERGENT PRODUCTS

Customer: Detergent product manufacturers

Product: Detergent

Installation details: All the raw materials are transferred into a conical mixer to produce the finished product. A bagging machine and a pelletizer ensure the final manufacturing of the product at the output of the mixer.

The granulator GR35 ensures the feeding mixer with a product free of lumps. The choice of the conical mixer with slow rotation as well as the mechanical design of the granulator GR35 ensures no degradation of the product and no creation of fine; the grain of the detergent is respected.

The line is designed to be cleaned in place.



▶ PACKAGING LINE OF FROZEN PAELLA

Customer: Group specialized in frozen food industry

Products: Paella

Installation details: The operators working in this manufacturing line ensure the feeding of the associative packing machine with frozen raw materials. The belt conveyor integrates several manual deconditioning positions. The granulator GR50 positioned at the end of the conveyor ensures the deagglomeration of the products as well as the overall line throughput.

The accuracy obtained at the output of the associative packing machine is assured by the sizing quality of the material.



Grinding Mills



Pin mills range

4 standard models: UM160 UM315 UM500 UM630

MICRONIZATION OF POWDERS

OPERATING SEQUENCE

The material supply is centralized. A magnetic separator is integrated upstream of the grinding chamber. The grinding is done by impact between the rows of pins concentrically mounted on the rotary disc. The particle size of the powder output is determined by three main factors:

- 1- Rotation speed
- 2- Number and shape of the pins
- 3- Passing air flow rate

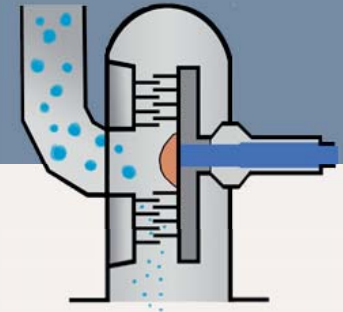

Models	UM160	UM315	UM500	UM630
Power in Kw	5.5	18.5	37	75
Theoretical flow in m ³ /hr.	250	1,000	2,000	3,600
Scale factor	0.25	1	2	3.6

*These flow rates are given on a production of icing sugar with an output particle size <130 microns for 98%.

POLY-MILL grinding mill offers the perfect solution for the grinding of a wide variety of bulk and powdered products. Each grinding process involves a specific solution according to the desired powder particle size. POLY-MILL pin mills are used for fine and ultra-fine grinding purposes (D50 = 5 microns) of crumbly or hard to grind dry materials.

Example of granulometric curve

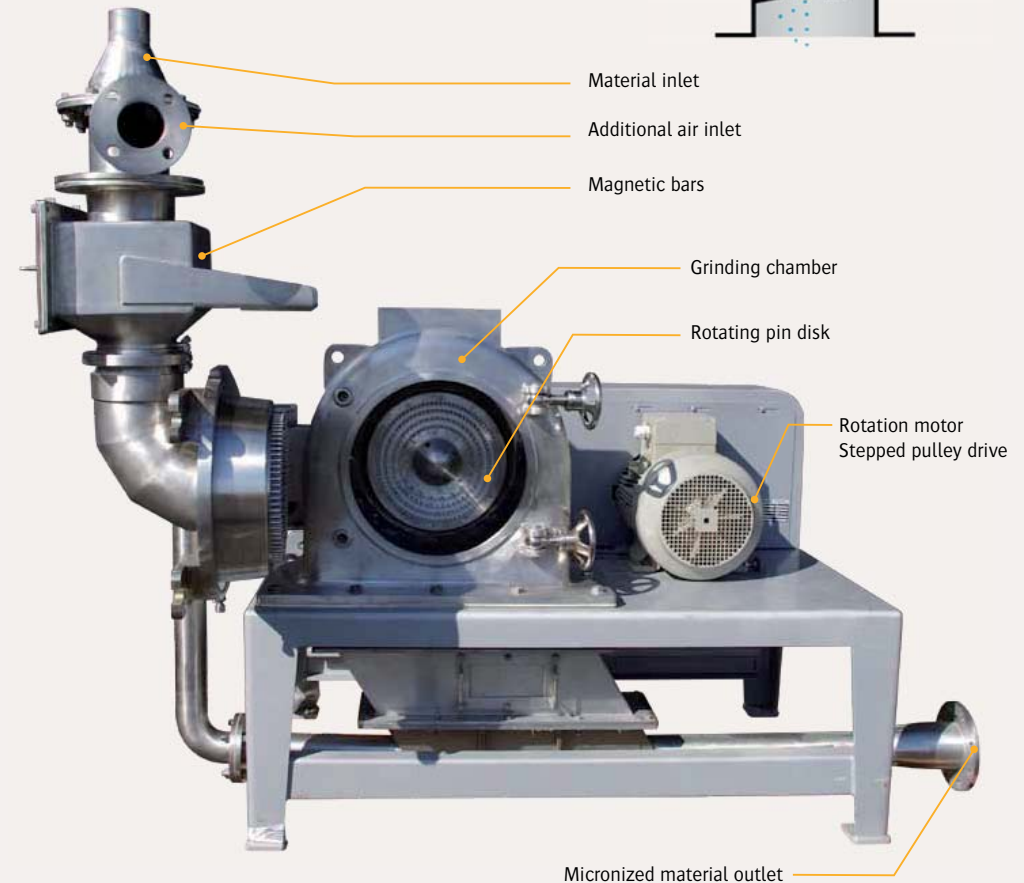
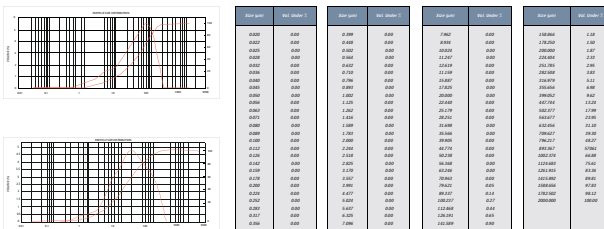

Grinding Mills



TECHNICAL CHARACTERISTICS

Designed with high mechanical strength, it does not only offer efficiency and safety of use, but also a grinding of a very high quality over long production periods.



FEATURES

- . Efficiency
- . Safety of use
- . Ease of maintenance and cleaning
- . Proven multi-product experience
- . No cross-contamination risk

APPLICATIONS

- . Food processing
- . Spices
- . Pharmaceuticals
- . Animal nutrition
- . Chemicals
- . Wood and plywood
- . Mineral powders
- . Plastics



DIMENSIONS

Models	A	B	C	D	ØD1	ØD2	E	F	G	KW	Max. Air Volume m ³ /hr.
UM160	625	645	714	1,340	76	165	660	1,210	1,115	5.5	400
UM315	910	1,035	614	1,524	168	280	910	1,470	1,105	18.5	1,500
UM500	1,185	1,035	614	1,800	219	336	910	1,470	1,280	37	3,200
UM630	1,450	1,335	614	2,065	219	336	1,215	2,620	1,462	75	5,500

Advantages

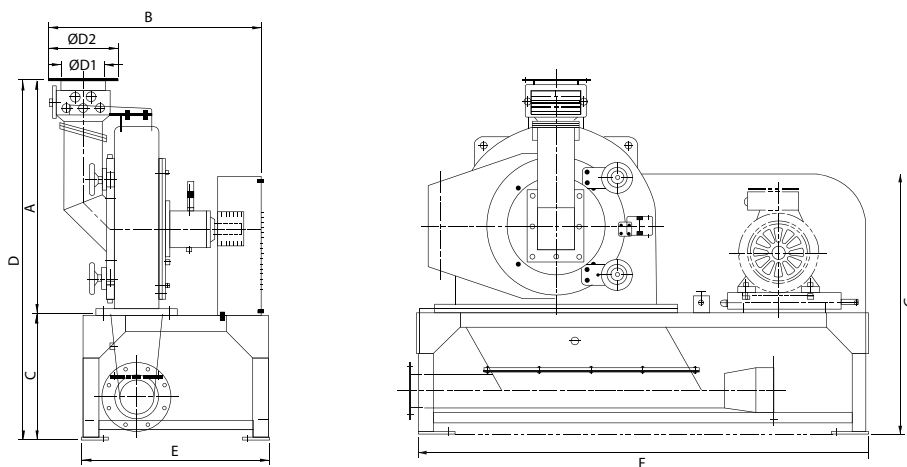

Engine configuration according to the space available:



▶ The engine mounting is carried out according to your implantation constraints.
In both configurations, the motor is located on an adjustable device ensuring the tension of the transmission belts.



▶ Easy access to the grinding chamber thanks to a large door and possibility of tool changing: implanting of blades and calibrating cages



▶ Reinforced shaft passage conception ensuring high rotation velocity and total sealing



▶ Ultra fine grain size thanks to a very high rotation velocity: up to 6,000 rev./min.



▶ Adjustable pin rows quantity

Conception Examples



▶ PROCESS IN THE FOOD INDUSTRY

Many powders to be grinded have significant explosive hazards. These materials, generally organic powders, require the installation of safety against explosions. This type of installation ensures dosing, grinding, conveying and extraction of the powder with all ATEX safety requirements.

Powders additions as additives or specific options can be studied by our research department.

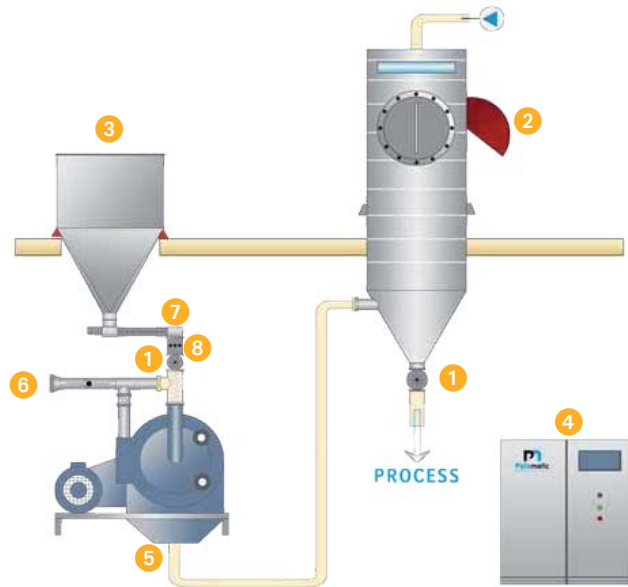

1 The rotary valve ensures the isolation of the volumes



2 The explosion vent allows the evacuation of the explosion pressure



3 Feeding hopper for the storage of raw material



4 The control panel ensures management of doses and flow rate



5 The venturi ensures the conveying of the micronized powder



6 VENTEX valve: flame check valve



7 The screw feeder enables precise feeding of the mill



8 Magnetic bars for the guarantee of a material free of foreign particles

▶ PROCESS OF ICING SUGAR GRINDING

The icing sugar manufacturing process represents an important activity of PALAMATIC PROCESS grinding applications. Complete sets of grinding ensure the proper particle size, the correct dosing of anti-caking agents, the quality of final product and the drop of temperature of the material. Its hygienic design is ideal for food applications.

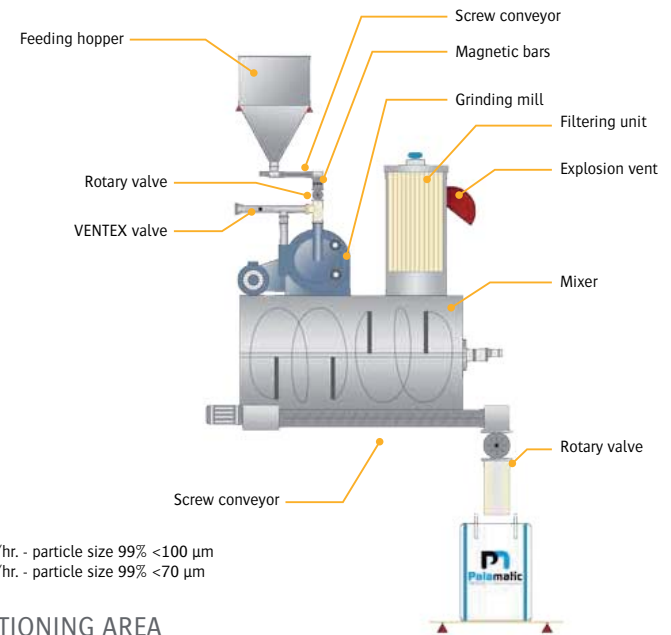

Characteristics

- Flow rate 3.5t./hr. - particle size 99% <100 μm
- Flow rate 2.5t./hr. - particle size 99% <70 μm

▶ CONDITIONING AREA



Examples of Granulator Installations

▶ COMPLETE LINE OF MICRONIZATION AND BAG CONDITIONING

Customer: Organic raw material manufacturer for the cosmetics industry

Products: Seaweeds

Installation details: PALAMATIC PROCESS has designed and manufactured a complete equipment line of micronization, debacterization and conditioning in bags.

Pre-crushed seaweeds are introduced in a controlled manner into the pin mill for micronization < to 40 microns.

After their granulation, seaweeds are transferred to the mixer for incorporation of complementary products. The mixer homogenizes and sanitizes the mixing in a controlled atmosphere. The final product is packaged in bags and weighed for sale.

The quality of the final product, ensured by the production line perfectly matches the customer's expectations.

PALAMATIC PROCESS turnkey solution was a success for this customized installation.



▶ COMPLETE GRINDING INSTALLATION IN ATEX ZONE

Customer: Moroccan group specialized in biscuits, chocolate and cocoa

Products: Crystal sugar

Installation details: Transform the crystal sugar in icing sugar to get a very fine grain for efficient and optimal use in the chocolate paste. The purpose is to avoid the creation of lumps without using additives.

PALAMATIC PROCESS industrial equipment: stainless steel manufactured sack dump unit with integrated sieve, Hygienic Sacktip®, stainless steel manufactured screw conveyor to feed the ATEX grinding mill with a rate of 1,5 t./hr., agitated storage tank with extraction screw, dedusting unit, rotary valve, bagging device, weighing tray and complete control cabinet.

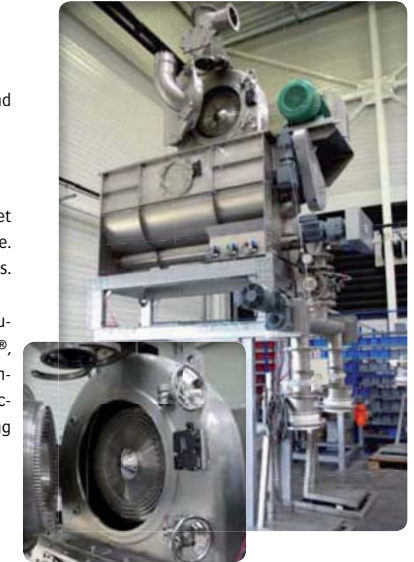

▶ CONDITIONING SYSTEM TO A GRINDING STATION FOR PEANUTS

Customer: This factory, client of PALAMATIC PROCESS, designs and sells chocolate products

Products: Peanuts

Installation details: Supply of a grinding station with peanuts in the customer's chocolate workshop. The supply of the mill must be carried out continuously by batch, with regulation of feed rate (+/- 1% accuracy).

The process line is fed thanks to a big bag unloading unit comprising: a hoist structure, a reception hopper, a weighed hopper, a feeder to allow the regulation of the flow to 70 kg./hr., a rotary valve, a pneumatic conveying system and an airlock (fitted between a feeder and a conveying system).



▶ DOSING AND GRINDING INSTALLATION FOR STARCH AND SUGAR

Customer: Sugar cooperative group

Products: Starch and sugar

Installation details: The starch and sugar mixture flows through a vibrating screen installed online to eliminate agglomerates and foreign bodies. To avoid flame rise in the process (upstream and downstream) and to allow dosing of sugar, three gravity rotary valves were installed. Sugar grinding is performed via our UM500 grinding mill which reduces the particle size of 700 microns to 60 microns.

The mill is composed of a motor of 37 Kw with a milling capacity of 2,200 kg per hour and a large door for easy inspection and maintenance.

At the output of the grinding mill, a reception tank for sugar fitted with a bridge breaker at the bottom prevents sugar caking and favors the descent of the powders and the feeding of the rotary valve. The bridge breaker speed is adjustable via a frequency converter.



EXAMPLES OF OUR PRIOR INSTALLATIONS



▶ Grinder for dried seaweeds



▶ Fix part of the grinding mill



▶ Lump breaker for road salt



▶ Granulator feeding the vacuum pneumatic conveying system



▶ Lump breaker integrated on a bag dump station of resin flakes



▶ Calibration trough for a high-quality final product



▶ Granulator integrated in a dump station



▶ Icing sugar grinding with mixing tank



▶ Crystal sugar grinding chamber



▶ Granulator GR70 for reprocessing waste



▶ Granulator for frozen food



▶ Lump breaker for waxy products



▶ Lump breaker with knives integrated into a big bag dumping station for wax tablets processing



▶ Magnetic bars in food grinding process



▶ Brown sugar crusher



▶ Granulator for pigments



▶ Conical lump breaker for veterinary products



▶ Lump breaker EC35 for sugar application

ATEX Guide for design of compliant equipment

▶ EQUIPMENT FOR SURFACE INDUSTRIES (GROUP II)

Zone	0	20	1	21	2	22
Type of atmosphere	G gas	D dust	G gas	D dust	G gas	D dust
Explosive atmosphere	Permanent presence		Intermittent presence		Episodic presence	
Category of devices that may be used in accordance with 94/9/CE	1		2		3	

▶ PRODUCT MARKING

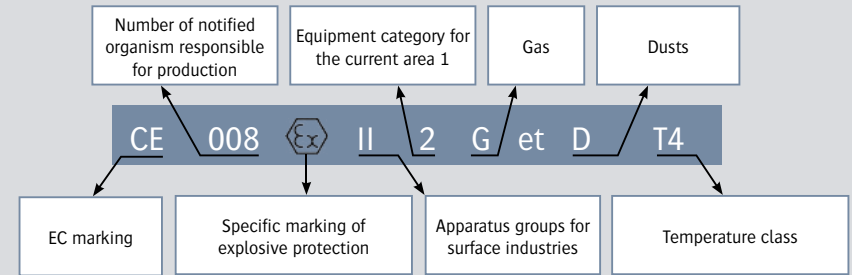

CONFORMITY ASSESSMENT PROCEDURE*

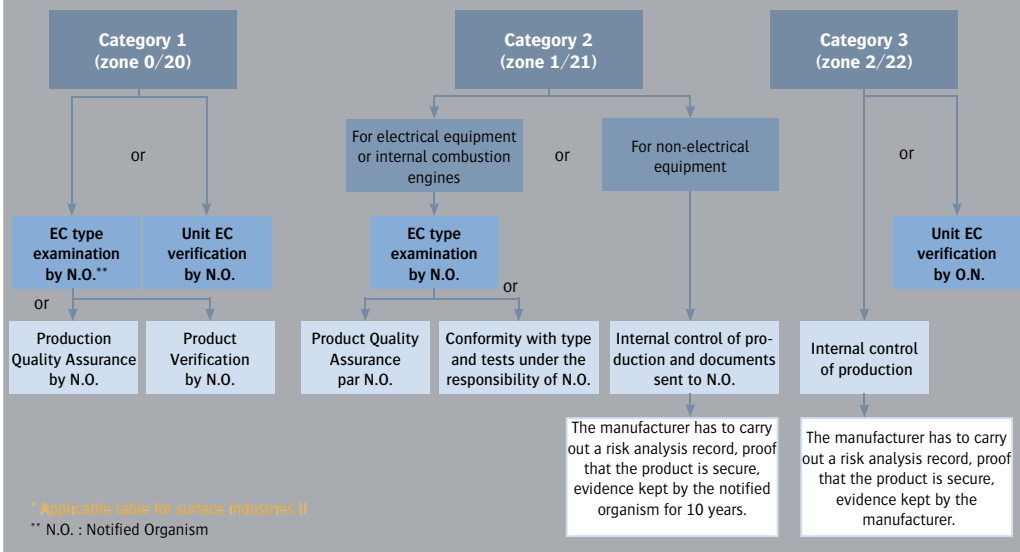

▶ DEGREE OF PROTECTION IP«XX»

Protection against solid bodies		Protection against liquid bodies	
0	No protection	0	No protection
1	Protected against solid bodies ≥50 mm (e.g. accidental contact of the hand)	1	Protected against vertically falling water drops
2	Protected against solid bodies ≥12 mm (e.g. fingers of the hand)	2	Protected against water falls inclined at 15 °
3	Protected against solid bodies ≥2,5mm (e.g. screw tools...)	3	Protected against rain water up to 60 ° from the vertical
4	Protected against solid bodies ≥1 mm (e.g. fine tools, small cord)	4	Protected against water sprayed from all directions
5	Protected against dust (no harmful sediment)	5	Protected against water jets with lance from all directions
6	Totally protected against dust	6	Protected against water splashes comparable to heavy seas
		7	Protected against the effects of immersion
		8	Protected against the effects of prolonged immersion under specified conditions

▶ GAS GROUPS

Group	Reference gas	MESG (mm)	MIC (mJ)
I	Methane	1,14	0,28
IIA	Propane	0,92	0,25
IIB	Ethylene	0,65	0,07
IIC	Hydrogen/acetylene	0,37	1,011/0,017

MESG: Maximum Experimental Safe Gap
 MIC: Minimum Ignition Current
 For flame arresters, additional subdivisions IIB1, IIB2 et IIB3
 IIB1: MESG > 0,85
 IIB2: MESG > 0,75
 IIB3: MESG > 0,65

▶ DUST GROUPS

Group	Type of dust	Size	Resistivity
IIIA	Suspended combustible particles	> 500 µm	-
IIIB	Non-conductive dusts	≤ 500 µm	>10 ³ Ω.m
IIC	Conductive dusts	< 500 µm	<10 ³ Ω.m

▶ MAXIMUM SURFACE TEMPERATURES

Gas	T1 (450)	T2 (300)	T3 (200)	T4 (135)	T5 (100)	T6 (85)
Dust	450	300	200	135	100	85

Our expertise:

FILLING SOLUTIONS FOR BIG BAG AND OCTABIN

To fill

EMPTYING SOLUTIONS FOR BIG BAG AND OCTABIN

To empty, compact and massage

SACK, DRUM AND CARDBOARD FILLING SOLUTIONS

To fill, package, handle

SACK AND DRUM EMPTYING SOLUTIONS

To empty, compact, handle, discharge

SOLUTIONS FOR PNEUMATIC CONVEYING

Vacuum, pressure

SOLUTIONS FOR MECHANICAL CONVEYING

To transfer with screw, belt conveyor, bucket elevator, aeromechanical or vibratory conveyor, truck loading spout

CRUMBLING AND GRINDING EQUIPMENT

To granulate, crumble, grind, pound, micronise, disagglomerate

SIFTING EQUIPMENT

To sift, segregate, sieve, protect

CONTAINERS AND STORAGE SOLUTIONS

To fill, charge, empty, contain

DOSING EQUIPMENT

To control, regulate, empty, extract

MIXING EQUIPMENT

To homogenise, incorporate, fluidify, stir, mix

FLOW AND CONNECTION

To vibrate, fluidise, unclog, drain, facilitate extraction, control the descent, prevent stacks and vaults, connect

INDUSTRIAL DUST COLLECTING EQUIPMENT

To filter, clean, confine, secure



contact@palamatic.fr

Sales Department: +33 (0)2 22 93 63 08

ZA La Croix Rouge • 35530 Brécé • France

Tel: +33 (0)2 99 86 06 22 • Fax: +33 (0)2 99 86 08 10

SAS au capital de 331 822 euros • R.C.S. Rennes B 384 894 093 • APE 4669B • N° T.V.A. : FR 14 384 894 093