

Doseur D10

contact@palamatic.fr
+33(0)2 99 86 06 22

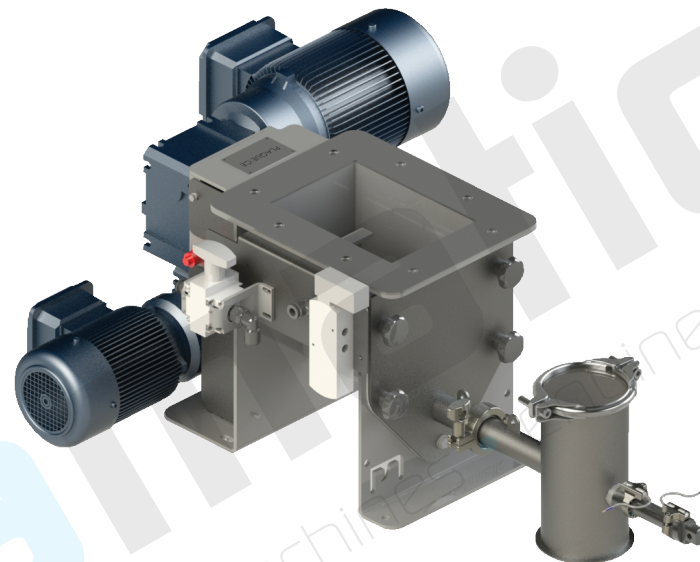

SANS VENTILATION FORCEE POUR
MOTEUR VIS DE DOSAGE

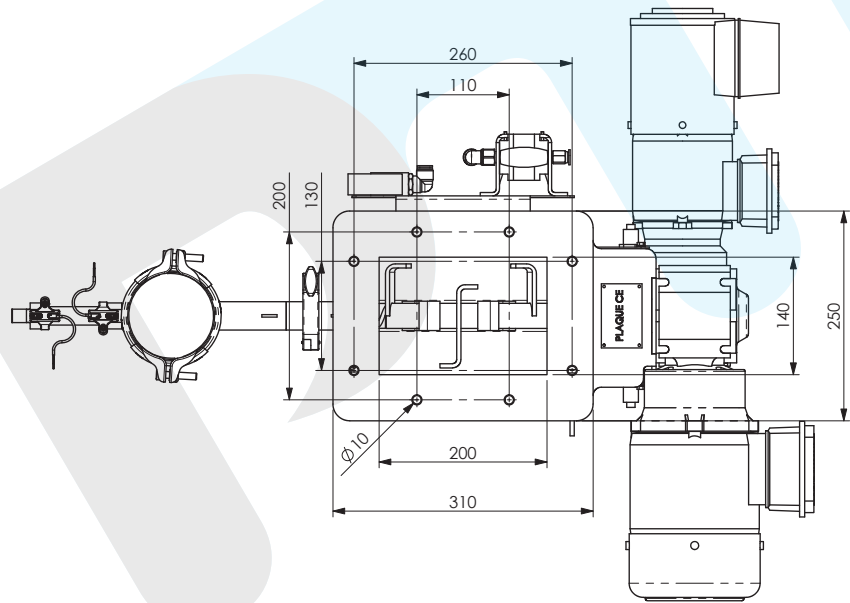
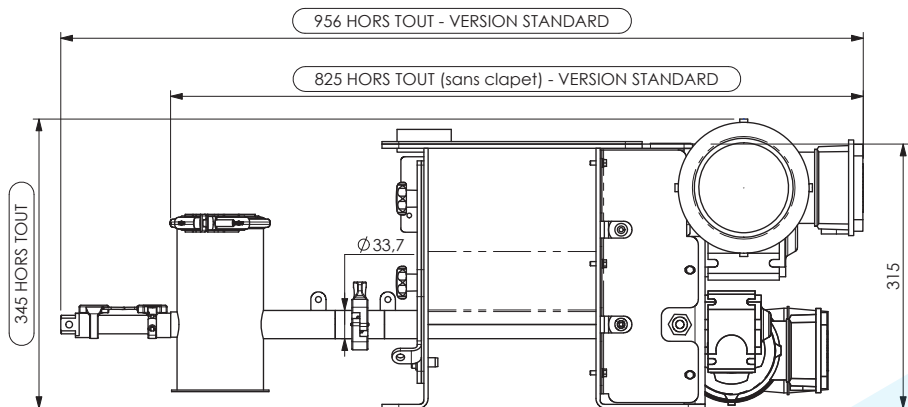
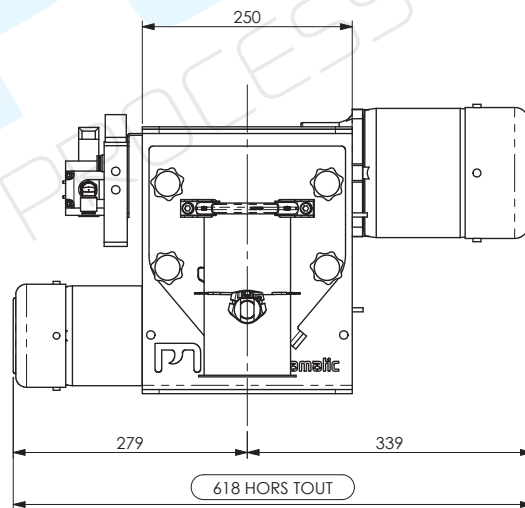

AVEC VENTILATION FORCEE POUR
MOTEUR VIS DE DOSAGE

